

# DM650XTM SENSOR/WALL MOUNTED ATEX / UKEX TEMPERATURE DISPLAY

## DM650XTM

- > **ATEX, UKEX and IECEx APPROVAL**

---

- > **UNIVERSAL TEMPERATURE RTD AND THERMOCOUPLE INPUT**

---

- > **6 DIGIT ALPHA-NUMERIC LCD DISPLAY**

---

- > **LOW COST DUAL 1.5V AAA BATTERY OPERATION**

---

- > **PUSH BUTTON AND NFC CONFIGURATION**

---

- > **DATA LOGGER (NFC INTERFACE)**

---



### > INTRODUCTION

The DM650XTM battery powered temperature indicator accepts RTD or thermocouple temperature sensors and displays the sensor temperature in °C, °F or K on a 6-digit LCD display. Configuration is achieved by operating a single push button and navigating a menu structure. A contactless NFC interface is also provided for configuration and the data logger function.

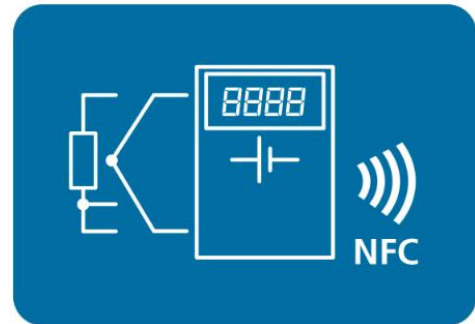

### > FEATURE HIGHLIGHTS

#### **ATEX / UKEX**

Approved for use in Category 1 Zones 0 (gas) and 20 (dust)

#### **BATTERY POWERED**

The instrument is powered by two AAA 1.5 V batteries. The battery life is dependent on the number of active features such as configuration response time and logging. Battery life is up to 5-years plus (1-year minimum depending on options selected).

#### **PUSH BUTTON CONFIGURATION (For ATEX / UKEX applications performed in non-hazardous areas only)**

Simple single-button menu allows the user to configure the sensor type, temperature units, decimal place, update rate and apply a single point user-offset (range -10.0 to 10.0 units) to correct sensor errors.

#### **NFC ANDROID CONFIGURATION FUNCTION (In safe area or with use of suitable ATEX / UKEX approved phone)**

The NFC Android interface allows configuration of the DM650XTM via an ATEX approved Android NFC device (or in safe area) using the downloadable App.

#### **NFC ANDROID DATA LOGGER FUNCTION (In safe area or with use of suitable ATEX / UKEX approved NFC device)**

Up to 1500 temperature, time and date-stamped log points can be recorded onto the DM650XTM.



## DM650XTM SENSOR/WALL MOUNTED ATEX / UKEX TEMPERATURE DISPLAY

INPUT RTD (3 Wire)		SPECIFICATIONS @20°C
Type	Range	Accuracy/stability
Pt100 (Europe) BS EN60751:1996	(-200 to 850) °C	±0.2°C, ±0.05% of reading (plus, sensor error)
Pt100 (USA)	(-200 to 630) °C	
Ni100	(-60 to 180) °C	
Ni120	(-80 to 260) °C	
Cu100	(-80 to 260) °C	
Cu53	(-50 to 180) °C	
Thermal drift	0 Ω (0 °C) drift at 20 °C	Typically, 0.01 Ω/°C Example Pt100 0.03 °C/°C
To maintain full accuracy, annual calibration is recommended. Contact support@status.co.uk for details		

INPUT Thermocouple		SPECIFICATIONS @20°C
Type	Range	Accuracy/stability
K	(-150 to 1370) °C	±0.5 °C, ±0.1% of full scale ± CJ error (plus, sensor error)
J	(-200 to 1200) °C	
N	(-180 to 1300) °C	
E	(-200 to 1000) °C	±0.5 °C, ±0.2% of full scale ± CJ error (plus, sensor error)
T	(-200 to 400) °C	
R	(0 to 1760) °C	±0.5 °C, ±0.1% of full scale ± CJ error (plus, sensor error) over range (800 to 1760) °C
S	(0 to 1760) °C	
L	(-100 to 600) °C	±0.5 °C, ±0.1% of full scale ± CJ error (plus, sensor error)
B	(0 to 1600) °C	
Thermal drift	0 uV (0 °C) drift at 20 °C	Typically, ±5 uV/°C
To maintain full accuracy, annual calibration is recommended. Contact support@status.co.uk for details.		

CASE SENSOR/AMBIENT TEMPERATURE Cold junction (CJ) error		SPECIFICATIONS @20°C
Type	Range	Accuracy/stability
Thermistor 10K Beta 3380	(-30 to 70) °C	±0.2 °C
Thermal drift	0 °C drift at 20 °C ambient	±0.05 °C/°C

DISPLAY	
Type/options/function	Description
Display height	7.9 mm non-backlit
Display information options, some information is displayed scrolling.	6 digits, 14 segment input value plus "Warning" icon. Resolution to one decimal place with unit character. Two decimal places (no units displayed).
Response rate	Reading every (5, 10, 30 or 60) s
Loss of input signal	Screen displays warning

NFC USER-INTERFACE ATEX / UKEX APPROVED NFC ENABLED ANDROID DEVICE REQUIRED (or use in safe area)		
Type/options/function	Type/options/function	Type/options/function
Configuration software	NFCLink	@ Google Play Store
Logging software	NFCLogLink	@ Google Play Store
Operating system	Android V4.4 Kitkat or later	NFC enabled
Logger parameters NFCLogLink	Start, set log parameters	Interval, (delay) start, number of points, rolling or fixed log, logging off
	Read log parameters	
	Synchronise clock	
	Reset maximum and minimum	



# DM650XTM SENSOR/WALL MOUNTED ATEX / UKEX TEMPERATURE DISPLAY

NFC USER-INTERFACE (continued) ATEX APPROVED NFC ENABLED ANDROID DEVICE REQUIRED (or use in safe area)		
Configuration parameters NFCLink	Tag/Name	Free type 24-character fields
	Lat/Long	Location data can be stored
	Sensor	RTD or TC type
	Units	°C, °F, K, °R
	Decimal place	0.0 or 0.00
	Offset	± 10.00 (Temperature units)
	Update rate	(5,10,30, 60) s



PUSH-BUTTON USER-INTERFACE CONFIGURATION	
Function	Description
Sensor	RTD: Pt100 Eu, Pt100 USA, Ni100, Ni120, Cu100, Cu53, Thermocouple: K, J, E, N, T, R, S, L, B, Tamb (ambient temperature)
Temperature units	°C, °F, K, °R
Decimal place	0.0, 0.00
Offset	± 10.00 (Temperature units)
Pass code	4-digit code to enable NFC connection, "0000" = default = off

Battery type Energizer L92				
Response time	5 seconds	10 seconds	30 seconds	60 seconds
Battery Life typical	(1 to 2) Years	(2 to 3) Years	(3 to 4) Years	(5 to 6+) Years
Battery life data obtained by calculation only. Worst case RTD Input. Ambient temperature 20°C, excluding any logger or configuration tasks. Battery life may vary with ambient operating temperature.				

GENERAL	
Function	Description
Response time	10 s
Warm up	3 minutes for full accuracy
ATEX / UKEX battery	2 x AAA 1.5 V Lithium, Energizer L92
Battery life	1-year minimum (longer depending on configuration)
Clock accuracy (logging)	± 2 s per month typically
Connections	Input sensor: Two-part screw connector

ENVIRONMENTAL	
Function	Description
Ambient temperature	Operating/storage (-20 to 60) °C
Ambient humidity	Operating/storage (10 to 90) %RH non-condensing
Protection	IP65, cable/probe entries must be sealed to IP65 to maintain protection
Android configuration ambient	(10 to 30) °C with ATEX / UKEX approved phone or in safe area

MECHANICAL	
Function	Description
Enclosure	ABS, grey base, grey clamp ring
Display cover	Polycarbonate, clear
Case entries	Base and side entry options see ORDER CODES below
Front of display diameter	65 mm
Weight (approximate)	175 g including base housing and batteries

APPROVALS	
Function	Description
EMC	BS EN 61326
Ingress protection	BS EN 60529, IP65
RoHS	Directive 2011/65/EU Incorporating Amendment Directive EU2015/863 and UK designated standard.
(UKEX) ATEX	(BS) EN IEC 60079-0:2018, (BS) EN 60079-11:2012
(UKEX) ATEX	(UKCA) CE  Ex ia IIC T4 Ga   (UKCA) CE  Ex ia IIIC T135°C Da
Working parameters	Uo = 3.66 V dc, Io = 17.0 mA, Po = 0.016 W
Terminals 1,2,3,4	



ORDER CODE							
<b>DM650XTM + SCH4 Housing (See below)</b>			The device must be used with the SCH4 housing to maintain ATEX / UKEX approval				
Order the DM650XTM with the required housing options							
SCH4 Housing							
Use this table to select the required SCH4 part number. Select body type (side or base) entry. Chose the threaded entry "Option" required from the "Entry options list" and add to the part number.							
SCH4 body type		Cap	Base entry	Side entry	Side entry	Entry options list	
Wall mount 1 x side entry	<b>SCH4</b>	<b>A</b>	<b>00</b>	<b>00</b>	<b>00</b>	<b>Option</b>	16 = M16 20 = M20 24 = M24 0.5BSP = 1/2" BSPP 0.5NPT = 1/2" NPTP
Sensor mount 1 x base entry	<b>SCH4</b>	<b>C</b>	<b>00</b>	<b>Option</b>	<b>00</b>	<b>00</b>	
Example DM650XTM with side entry M20 entry housing							
<b>DM650XTM</b>	+ Order with SCH4 housing						
	<b>SCH4</b>	<b>A</b>	<b>0</b>	<b>00</b>	<b>00</b>	<b>20</b>	
For further options please contact sales@status.co.uk							

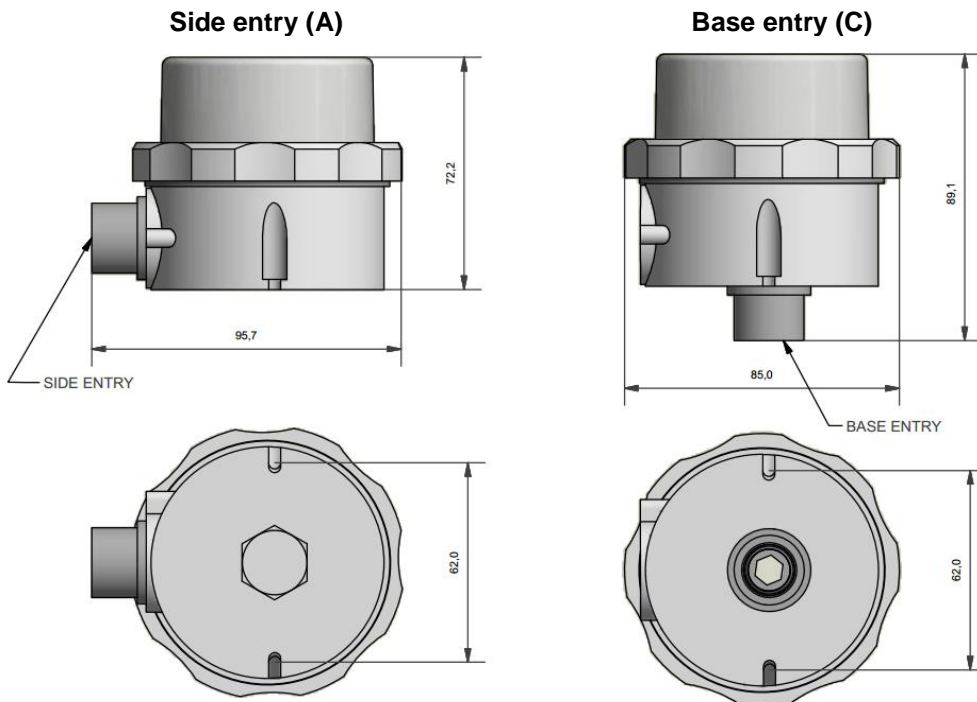

Dimensions in mm

ACCESSORIES	
Battery AAA 1.5 V lithium	Refer to sales@status.co.uk
NFC logging software	NFCLogLink free of charge @ Google Play Store
NFC configuration software	NFCLink free of charge @ Google Play Store
Temperature probe options	www.status.co.uk

The data in this document is subject to change. Status Instruments assumes no responsibility for errors.  
To maintain full accuracy annual calibration is recommended contact support@status.co.uk for details.



# DM650XTM SENSOR/WALL MOUNTED ATEX / UKEX TEMPERATURE DISPLAY

## Addendum: NFC SOFTWARE



**IMPORTANT**

NFC functions are only to be carried out in the safe area or with a suitably approved ANDROID ATEX / UKEX device.

### NFC Link configuration software

The NFC interface allows the instrument to communicate with an Android device using NFC connectivity.

The prime function of the interface is to configure the device using the free app, which is available for downloading to Android devices. Status Instruments apps are available on the Google Play Store.

The app allows the user to set the parameters shown in the configuration screen (below).

Tag No and Contact are free-type fields, saved onto the device.

Latitude and Longitude can be used to add the unit's location, which is added to the log in the NFC LogLink software.

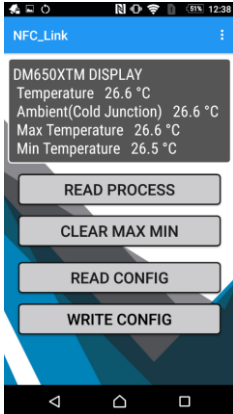

Read process screen

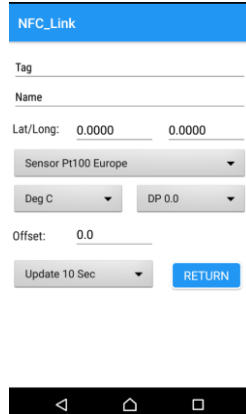

Configuration screen

### NFC Loglink logging software

The NFC interface allows the instrument to communicate with an Android device using NFC connectivity.

The prime function of the interface is to read logged data from the device using the free app, which is available for downloading to Android devices. Status Instruments apps are available on the Google Play Store.

The app allows the user to read existing logs, change the log manifest, start a new log, synchronise the instrument clock and reset the maximum/minimum readings.

Logs can run to a fixed number and stop when the pre-set limit is reached, or continually roll over. Up to 1500 log points can be recorded. The start of the log can be delayed by up to one month.

Data from NFCLogLink can be viewed on screen as a graph or table and can also be saved to a csv text file.

**Note:** For larger logs the data may take up to a minute to fully download via the NFC interface.

**Note:** Not all Android devices fully implement the near field communication (NFC) standard and may not hold the full 1500 log points.

NFC LogLink screens.



Main menu

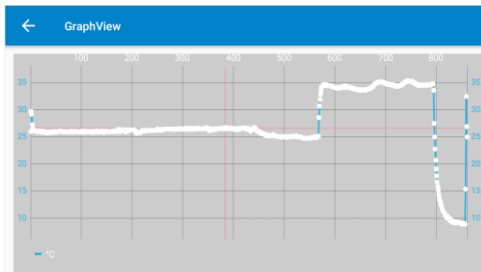

Graph view in NFCLogLink

Log	Date	Time	°C
223	18/11/19	13:20:08	25.99
224	18/11/19	13:20:18	25.99
225	18/11/19	13:20:28	25.99
226	18/11/19	13:20:38	26.18
227	18/11/19	13:20:48	26.18

Data table view in NFCLogLink

